

KEY FEATURES

- Switching Power Module for PCB Mountable
- Universal Input: 85-265 VAC
- Single Output
- 5 VDC to 48 VDC Output
- -40°C Starting
- Screw Terminal For Optional
- 4000 VAC Input to Output Isolation
- CE, UL, Approval
- 2-Years Product Warranty



ELECTRICAL SPECIFICATIONS

Model No.	AEC60-5S	AEC60-9S	AEC60-12S	AEC60-15S	AEC60-24S	AEC60-48S	
Max Output Wattage (W)	50W	60W	60W	60W	60W	60W	
Input	Voltage						85-265 VAC or 100-370 VDC
	Frequency (Hz)						47-63 Hz
	Current (Full load)						2 A max. (115 VAC) / 1 A max. (230 VAC)
	Inrush Current (<2ms)						30 A max. (115 VAC) / 50 A max. (230 VAC)
	Leakage Current						0.5 mA max.
Output	Voltage (V.DC.)	5V	9V	12V	15V	24V	48V
	Voltage Accuracy	±2%					
	Current (mA) max	10,000	6,660	5,000	4,000	2,500	1,250
	Line Regulation (LL-HL) (typ.)	±1%					
	Load Regulation (5-100%) (typ.)	±1%					
	Minimum Load	1%					
	Maximum Capacitive Load	80000 uF	28000 uF	14000 uF	12000 uF	4000 uF	950 uF
	Ripple	<0.2% Vout +40mV max (Vp-p)					
	Noise	<0.5% Vout +50mV max (Vp-p)					
	Efficiency (at 230V)	82%	84%	86%	86%	86%	86%
	Trim	±10%					
	Hold-up Time	10 ms min.					
Switching Frequency	100 kHz						
Protection	Over Power Protection	Auto recovery					
	Over Voltage Protection	Zener diode clamp					
	Short Circuit Protection	Auto recovery					
Isolation	Input-Output (V.AC)	4000V					
	Input-FG (V.AC)	1500V					
	Output-FG (V.AC)	500V					
Environment	Operating Temperature	-40°C...+70°C (with derating)					
	Storage Temperature	-50°C...+85°C					
	Temperature coefficient	±0.02%/°C					
	Humidity	95% RH					
	MTBF	>130,000 h @ 25°C (MIL-HDBK-217F)					
Physical	Dimension (L x W x H)	4.3 x 2.3 x 1.18 Inches (109.0 x 58.5 x 30.0 mm) Tolerance ±0.1 mm					
	Weight	310 g					
	Cooling Method	Free air convection					
Safety	Agency Approvals	CE, UL60950					
EMC	EMI (Conducted & Radiated Emission)	EN 55022 class B					
	EMS (Noise Immunity)	EN 55024					

1.All specifications valid at nominal input voltage, full load and +25°C after warm-up time unless otherwise stated.

2.Ripple & Noise are measured at 20MHz of bandwidth with 0.1uF & 47uF parallel capacitor.

MECHANICAL DIMENSION (Top View)

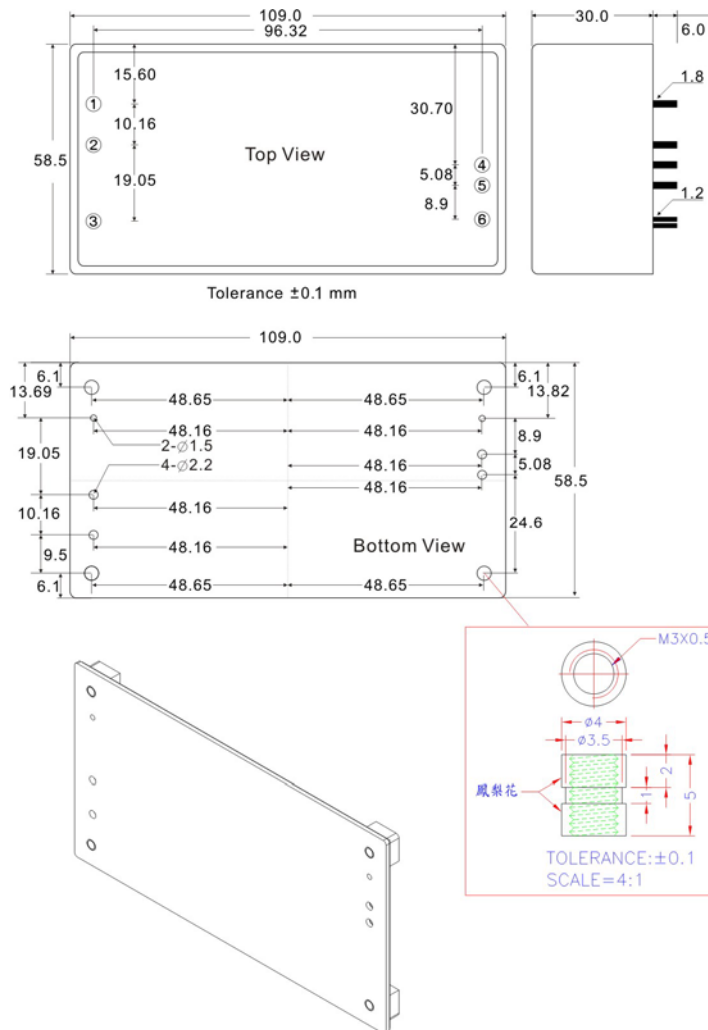

PIN#	SINGLE
1	AC IN (N)
2	AC IN (L)
3	FG
4	+DC OUT
5	-DC OUT
6	Trim

DERATING

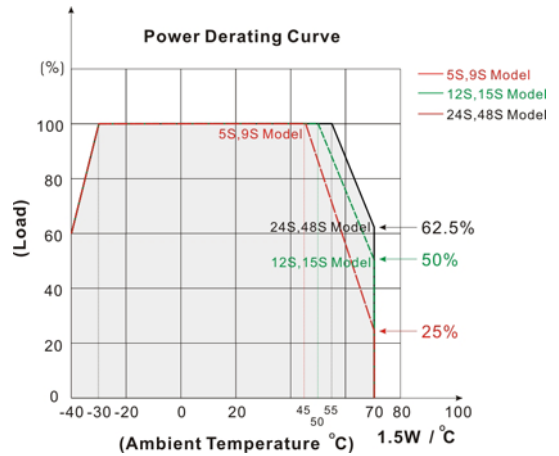

BLOCK DIAGRAM

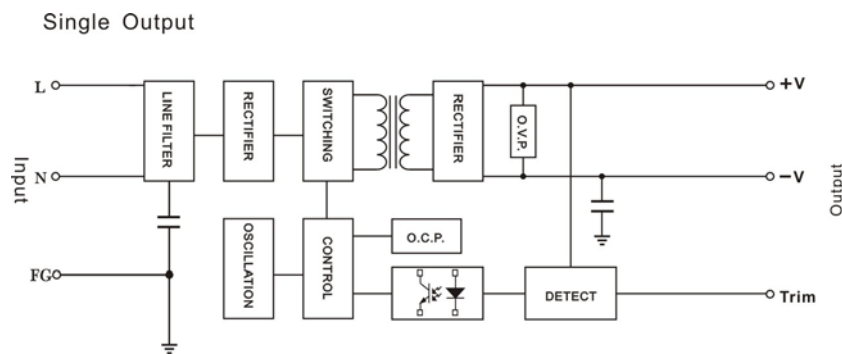

SCREW TERMINAL
AEC60-A2

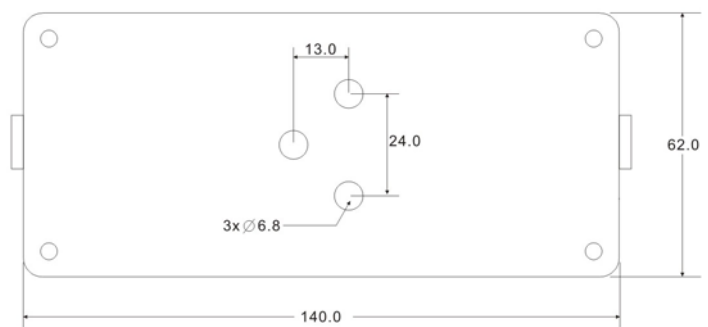
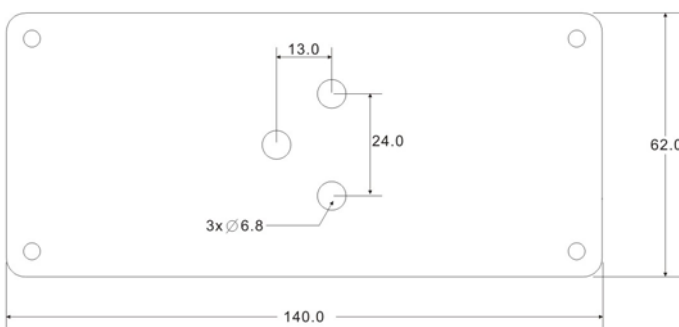
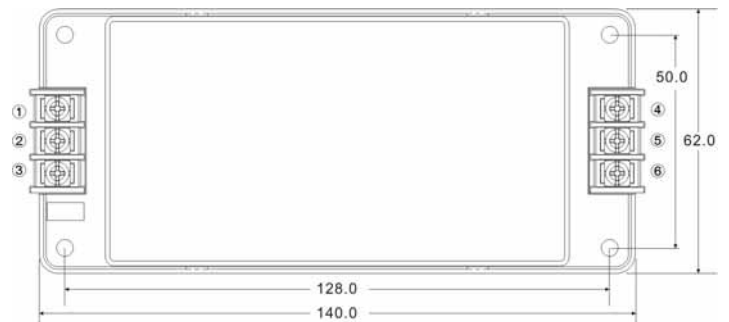
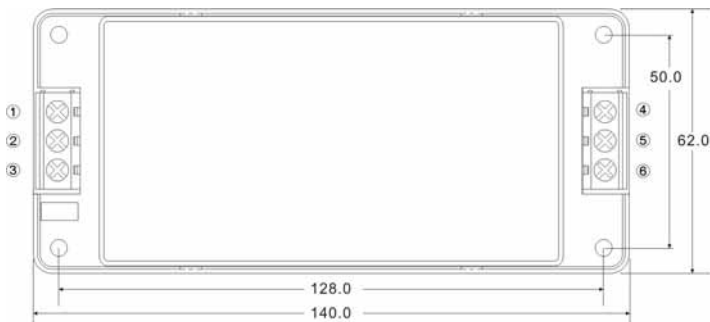
AEC60-A5

PIN#	Single
1	FG
2	AC IN (N)
3.	AC IN (L)
4	+DC OUT
5	-DC OUT
6	Trim

PIN#	Single
1	FG
2	AC IN (N)
3.	AC IN (L)
4	+DC OUT
5	-DC OUT
6	Trim